

Industry's most complete
WiMAX product family
in the widest selection
of frequency bands



WiMAX Solutions



Airspan's WiMAX Deployments Around the World



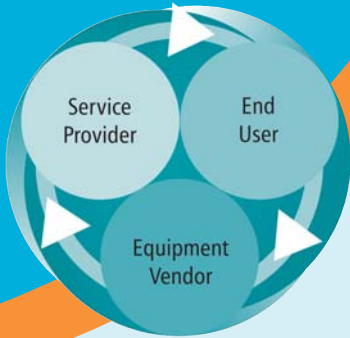

Introducing WiMAX

- Over 400 customers in more than 100 countries
 - Maximize your CAPEX and OPEX returns
- The widest range of WiMAX products
 - Base stations
 - End User devices
 - ASN Gateways
 - VoIP Admission Control servers
 - Network management
- The widest selection of frequency bands
 - From 700MHz to 5.9GHz
- The most advanced technologies
 - Software Defined Radio
 - MIMO
 - OBSAI
 - ATCA
- Professional services
 - Radio planning
 - Network design
 - Post-sales technical support

Airspan - The Recognized Leader in WiMAX

- The widest range of WiMAX products
- The widest range of frequency bands
- The most advanced technologies and features

Airspan is a worldwide leader in broadband wireless with over 400 customers in more than 100 countries.

As a founding member of the WiMAX Forum™, Airspan has led the way in WiMAX, being among the first wave of companies to achieve certification for its base station and end user premises equipment.

Airspan is also leading the race to Mobile WiMAX. Through a careful choice of advance technologies, the flagship base station HiperMAX is software upgradeable to Mobile WiMAX. The recently announced MacroMAXe and MicroMAXe products also use the same baseband technology first developed for HiperMAX.

The IEEE 802.16e-2005 compliant, quad-band MiMAX USB device, announced in 2006, will be the first Wave2 compatible Mobile WiMAX device for laptops.

Airspan has always taken the lead to bring real-world solutions to WiMAX networks. Two examples of particular note are the seamless integration of WiMAX and Wi-Fi technologies and the introduction of VoiceMAX.

Airspan's Intel-based EasyST and ProST CPEs have versions with Wi-Fi Access Point functionality. This

capability enables them to simultaneously offer both WiMAX and Wi-Fi, thus enabling the service provider to address a variety of markets including fixed, nomadic, portable and Mobile WiMAX together with any Wi-Fi enabled device.

The challenges associated with delivering time critical services such as voice and video over a shared medium such as wireless access are well known. Airspan's VoiceMAX gives operators the ability to deliver carrier-grade VoIP through a software suite that provides admission control and manages network congestion to deliver the best user experience for VoIP calls across a HiperMAX network operating fixed, nomadic and mobile profiles simultaneously.

We in Airspan believe that now is the right time to build your WiMAX network. The advanced technologies we have embedded into our products ensure that whether you plan to start with Fixed WiMAX and migrate to Mobile WiMAX in the future or go for Mobile WiMAX from the outset, your investment is safe and your network is ready for tomorrow's opportunities.

Its industry leading technologies and solutions coupled with years of experience of building and supporting large BWA networks make Airspan the ideal partner for Mobile and Fixed WiMAX deployments.



Mobile WiMAX – A Technical Overview

The IEEE 802.16e-2005 Mobile WiMAX standard has been developed to be the best wireless broadband standard for portable devices enabling a new era of high throughput and high delivered bandwidth together with exceptional spectral efficiency when compared to other 3G+ mobile wireless technologies such as HSPA and EV-DO.

Mobile WiMAX introduces scalable OFDMA and several other key features summarized below:

- Tolerance to multipath and self interference
- Scalable channel size up to 20MHz
- TDD operation to support asymmetric traffic
- Network optimized hard handover
- Multicast and broadcast service support
- Hybrid ARQ based error control
- Power management (sleep, idle modes)
- Security and QoS
- MIMO and smart antenna technology
- Fractional frequency reuse
- Feedback based adaptive modulation

Mobile WiMAX Release 1.0 Air Interface Profile

Early in 2006 the WiMAX Forum™ selected the candidate certification profiles to cover many of the worldwide spectrum allocations suitable for Mobile WiMAX.

- Bands - 2.3-2.4GHz, 2.5-2.69GHz, 3.3-3.4GHz, 3.4-3.8GHz

- Duplex method - TDD
- Channel Bandwidth - 5/7/8.75/10/20MHz
- FFT size - 512 (5MHz channel), 1024 (10MHz channel) and 2048 (20MHz channel)

Mobile WiMAX Certification

Mobile WiMAX Release 1 Profile certification has been divided into two stages referred to as Wave 1 and Wave 2.

Wave 1 certification addresses a single certification profile targeted at the Korean market. It excludes some fundamental features such as MIMO. True Mobile WiMAX performance is achieved through Wave 2 certification.

Wave 1 does not test for:

- MIMO 2x2 Matrix B
- Support for smart antennas
- Adaptive Modulation and Coding (AMC)
- IPv6 support
- Complete QoS features
- Complete Handover features
- Complete power management features

As a result of the above-identified limitations the performance of the Wave 1 certified products would be less than those of IEEE 802.16-2004. Furthermore not all Wave 1 certified CPEs will be Wave 2 MIMO capable.

Airspan is focused on delivering Wave 2 compliant products, targeted at global profiles in 2.5GHz as well as the other profiles listed above.

A New Era in Wireless Communications

Main Features

- Carefully chosen set of technologies to provide superior performance
- Mobile WiMAX peak data rates and spectral efficiency are better than 3G and 3G+ technologies
- Mobile WiMAX certification to be achieved in two stages, Wave 1 and Wave 2
- True Mobile WiMAX performance will be arrived at through Wave 2 certification
- MIMO (Matrix A & Matrix B) and beamforming are essential antenna technologies to deliver the promise of Mobile WiMAX
- Option to overlay beamforming on top of MIMO
- Mobile WiMAX network architecture follows NRM
 - Mobile Station (MS) e.g. MiMAX USB
 - Access Service Network (ASN) e.g. ControlMAX and HiperMAX
 - Connectivity Service Network (CSN) Industry standard solutions plus Airspan's VoiceMAX

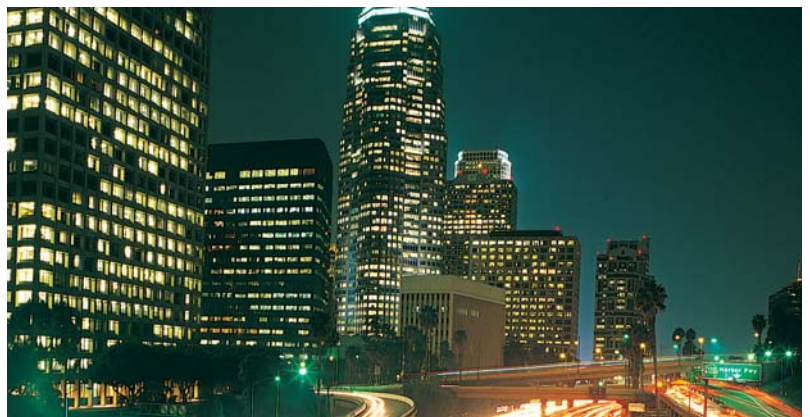

Mobile WiMAX Performance

Using a commonly accepted evaluation methodology for 3G systems, Mobile WiMAX has been simulated against the 3G enhancements. These simulations have shown that:

- Mobile WiMAX peak data rates are better than 3G and 3G+ technologies and
- Mobile WiMAX spectral efficiency is better than any 3G and 3G+ technology

Thanks to technologies such as OFDMA and MIMO, Mobile WiMAX can meet the demanding performance needs for the delivery of broadband services in a challenging mobile environment. Performance simulations show that Mobile WiMAX provides superior throughput and spectral efficiency compared to 3G CDMA-based enhancements, EVDO and HSPA. These advantages will provide operators with added network capacity for the support of value-added services with fewer base stations than alternative approaches, thus resulting in lower network capital and operating costs.

Mobile WiMAX Network Reference Model (NRM)

Mobile WiMAX end-to-end network architecture model follows the Network Reference Model (NRM) shown below.

Access Service Network (ASN) consists of the WiMAX Base Stations and the ASN Gateway. The main functions of the ASN gateway are to aggregate the traffic from the base stations and to manage handover between them. Airspan's ASN Gateway solution is called ControlMAX and is described later.

Connectivity Service Network (CSN) is the core of the network. It controls and manages the ASNs and the subscribers with a variety of services including AAA, Home Agent functions, DHCP server, etc. CSN is also responsible for connecting to other networks and enables inter-operator and inter-technology roaming. Airspan's VoiceMAX solution resides in the CSN and is described later in this document.

Airspan's Mobile Station (MS) device, MiMAX USB, is Wave 2 compliant from the outset and supports MIMO.

Mobile WiMAX Technology

To deliver the superior performance Mobile WiMAX relies on advanced technologies such as scalable OFDMA, MIMO and SAS.

MIMO stands for Multiple Input Multiple Output. It is an antenna technology that uses multiple antennas at both the transmit end and the receive end. MIMO utilizes multi-path to advantage, combining reflected signals into a single stream in order to improve throughput, reach and spectral efficiency.

Smart Antenna Systems (SAS) is an advanced antenna technology that directs the signal to the end user device. Using beamsteering/beamforming technology, SAS focuses the signal on active devices, delivering greater coverage and spectral efficiency. Airspan's antenna technology enables the overlay of SAS on top of MIMO.

Network Reference Model (NRM)

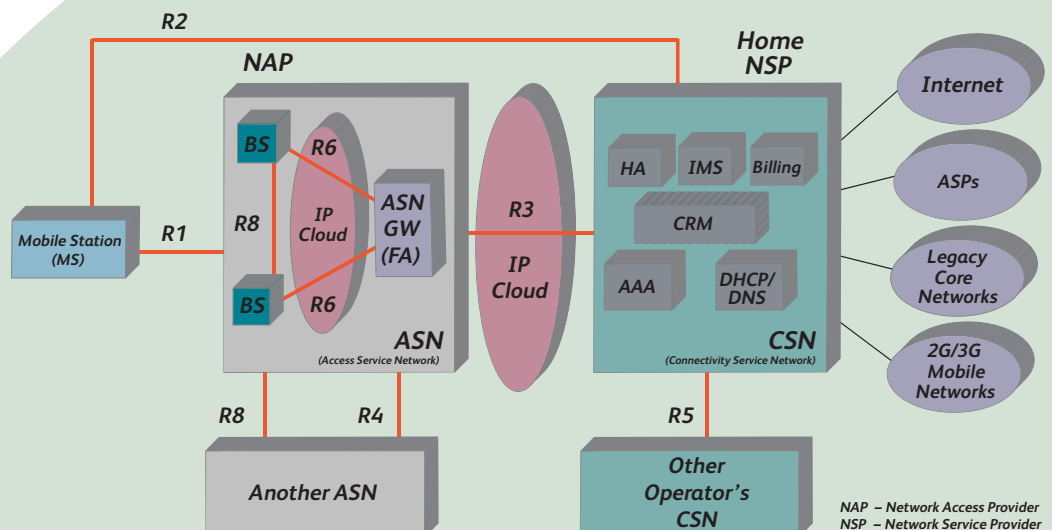



A World of Mobile and Fixed WiMAX Applications

Application Summary

- Wireless Broadband Anytime, Anywhere
 - Broadband @ Home
 - Broadband @ the Office
 - Broadband on the Move
- Mobile, fixed, nomadic and portable operation
- Indoor and outdoor coverage
- Mobile WiMAX enabled through USB, PC card and handsets
- WiMAX provides wide area Hot Zones
- Backhaul and bridging applications

WiMAX Applications

WiMAX has already revolutionized the broadband wireless market by standardizing the hitherto fragmented Broadband Wireless Access (BWA) market, by opening up new service opportunities and by creating the environment for ubiquitous broadband services everywhere.

WiMAX bridges the fixed wireline broadband and the mobile cellular divide. By deploying WiMAX technology, service providers can offer not just fixed broadband wireless services to homes and businesses; they can also offer anytime, anywhere mobile access to IP services at much higher speeds than is possible with voice-centric 3G networks.

Let's now consider some of the IEEE 802.16e-2005 WiMAX applications below.

Broadband on the Move

Mobile WiMAX enables the service providers to offer 'anytime-anywhere' broadband services over a wide coverage area. Mobile WiMAX expands the Wi-Fi hotspot concept into Hotzones, enabling the service providers to offer consistent and reliable wide-area broadband coverage over the metropolitan areas, thus encouraging customer commitment and loyalty.

Mobile WiMAX takes broadband outside the confines of the home or the workplace. Thanks to 'anytime-anywhere' true broadband experience offered by WiMAX, new and exciting services become a reality in all walks

of life, covering social networking, education, emergency services and the business world to name a few.

Mobile broadband opens up a whole new high-speed data experience, which cannot be matched by the other mobile technologies available today. Imagine you decide to go for a walk to the nearby park during your lunch break to enjoy the sunny weather. You receive a VoIP call from one of your customers asking you to confirm product availability immediately so that they can place the order. You start a data session on your WiMAX enabled device, log on to the server at work and check the latest stock position. You then proceed to send an e-mail to your customer confirming that the product is in stock and you receive the order before you have returned to your desk.

Airspan has grasped this vision and has set out to develop a range of products to fully exploit the potential of Mobile WiMAX. To this end we have developed the HiperMAX, MacroMAXe and MicroMAXe base stations using SDR technology to ensure soft upgrade to support the latest version of the Mobile WiMAX standards and services without requiring hardware changes.

Airspan has also recognized that Mobile WiMAX requires diverse and plentiful WiMAX enabled end user devices and has developed the world's first quad-band MiMAX USB device for laptop computers. Find out more later in this document.



Fixed Broadband

WiMAX appeals to a wide cross section of service providers, new entrants, mobile service providers and traditional wireline operators alike. WiMAX is appealing to new entrants and mobile service providers that want to also provide high-speed broadband services to the home and the office. WiMAX is also being embraced by the wireline operators as a cost-effective way to expand their broadband service offerings to underserved areas. Using WiMAX, wireline operators can cover rural and less dense environments where the cost of expanding DSL and cable wiring is prohibitive, as well as dense urban areas where it may be difficult to add wired connections to existing large buildings such as apartment blocks and office buildings.

Airspan offers a range of base stations that provide the optimum CAPEX and OPEX solutions in both dense urban and less dense sub-urban and rural deployment scenarios. Furthermore, Airspan has been the first WiMAX vendor to offer a complete range of indoor and outdoor integrated WiMAX and Wi-Fi end user devices. These products benefit both the service provider and the consumer. The service providers can rapidly deploy indoor and outdoor Wi-Fi hotspots with built-in

WiMAX backhaul, whereas the consumers enjoy the benefit of accessing the WiMAX broadband connection anywhere within their dwelling. Another market for integrated WiMAX and Wi-Fi CPE with considerable potential is temporary deployments, such as trade shows, sports venues and emergency relief.

Campus Applications

Many government, enterprise and educational organizations have deployed Wi-Fi technology in buildings for their respective users. WiMAX allows a service provider to offer broadband connectivity beyond individual buildings to provide complete coverage of an entire campus for data, VoIP and multimedia applications. Furthermore, thanks to the advanced QoS and security features offered by WiMAX, it becomes possible to create a secure and reliable communications environment.

The integration of WiMAX and Wi-Fi in a single end user device enables users to connect to either in-building Wi-Fi or campus-wide WiMAX networks, allowing them to

stay connected as they roam from location to location. This model also helps save OPEX expenses by minimizing the number of Wi-Fi access points required to achieve complete broadband coverage across the campus.

Backhaul applications

WiMAX products lend themselves to backhaul and bridging applications. We have already discussed how WiMAX can provide a cost effective and highly integrated backhaul environment for Wi-Fi hotspots. In some deployment situations it would be attractive to use WiMAX compliant links, operating in an unlicensed band such as 5.8GHz, to backhaul the base station traffic towards the core network. A third application could be LAN-LAN bridging solutions for campus networks or indeed for providing IP connectivity.

Airspan's MicroMAX product range is particularly suitable for backhaul applications providing high availability with native IP interfaces, in both licensed and unlicensed bands.

Mobile WiMAX Scenarios

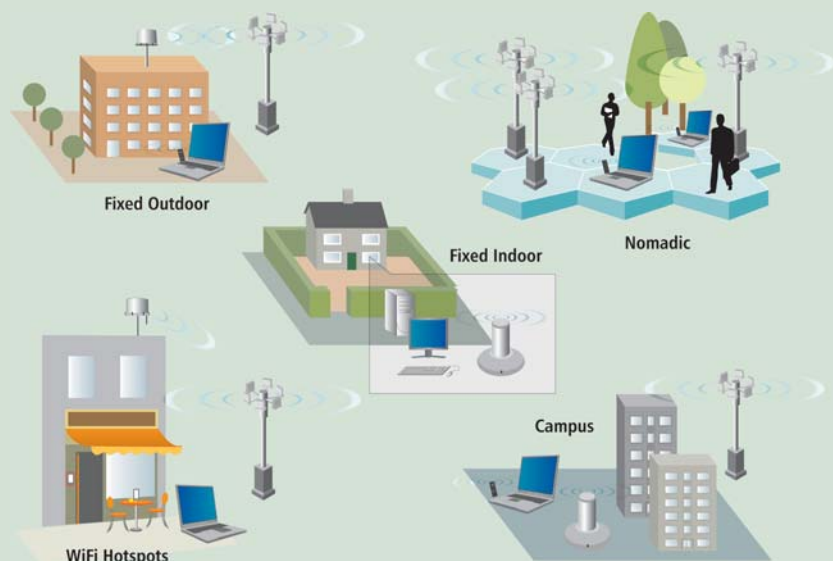



The Ultimate WiMAX Product Family

Product Summary

- Base Stations
 - HiperMAX
 - MacroMAXd
 - MacroMAXe
 - MicroMAXd
 - MicroMAXe
- End User Devices
 - MiMAX USB
 - EasyST
 - EasyWiFi
 - EasyVoice
 - ProST
 - ProST-WiFi
- Network Products
 - ControlMAX
 - VoiceMAX
- Network Management
 - Netspan

Airspan's WiMAX Product Portfolio

- Delivering optimized CAPEX, minimized OPEX
- Complete range of interoperable products with class leading performance optimize CAPEX for all deployment scenarios
- Highly integrated, compact packaging and low power consumption minimize site OPEX costs

Airspan is proud to introduce the industry's most complete range of WiMAX products consisting macro and micro-cell base station solutions, a range of indoor, outdoor and mobile end user devices, network products and a comprehensive network management solution.

Airspan's WiMAX products benefit from a unique combination of features delivering the best economics and most attractive service propositions for mobile and fixed/nomadic/portable broadband:

- Wide selection of base stations types enable improved network economics.
- Modular and highly integrated products encourage scalable network deployment that improves CAPEX and OPEX performance.
- Open architecture enables interoperability.
- Wide range of Licensed and Unlicensed bands supported (1.5GHz, 2.3GHz, 3.3-3.8GHz, 4.9GHz, 5.1-5.4GHz, 5.4-5.7GHz, 5.8GHz, 5.9GHz followed by 500-700MHz)
- Class leading spectral efficiency
- High Performance radios that deliver extended link budgets
- Low latency radio interface for time critical services

Airspan's WiMAX technology has been carefully chosen to deliver IEEE 802.16e-2005 Mobile WiMAX. It also provides operators with a cost effective and future-proof evolution path from Fixed to Mobile WiMAX profiles.

Airspan offers the ideal WiMAX platform on which to deploy an industry standard broadband solution. It provides all the benefits of multi-vendor interoperability, decreasing CPE costs, WiMAX enabled handheld device portability with roaming and indoor, self install CPE economics, thus heralding a new era of inexpensive, ubiquitous broadband wireless access anytime, everywhere.

Airspan's WiMAX Strategy

Airspan's WiMAX strategy is to offer a comprehensive end-to-end solution for Mobile and Fixed WiMAX deployments through standards compliant, interoperable, WiMAX Forum™ certified products; empower the end-user through personal broadband; provide real-world solutions to coexistence with other wireless systems; enable seamless upgradeability to Mobile WiMAX through the use of Software Defined Radio (SDR) and to offer unrivalled spectral efficiency through the use of advanced antenna techniques such as MIMO and Smart Antenna Systems.



HiPERMAX-micro deployment in urban Tokyo

Technology Showcase

- Software Defined Radio (SDR) - essential technology for simultaneous support of both Fixed and Mobile WiMAX PHY/MAC
- Advanced RF features
 - Transmit and Receive Diversity to improve link budget
 - MIMO - Multiple antenna elements are employed to improve range and throughput
 - Intelligent, beamforming antenna technology to improve link budget and spectral efficiency
- Intel technology in the End User Devices – essential technology for low cost and future-proof functionality
- MiMAX USB – World’s first and smallest WiMAX USB device, turning every laptop into a WiMAX enabled personal broadband device, enabling mobility, roaming and interoperability
- Advanced TCA (ATCA) - Industry standard Indoor equipment practice for base stations
- Fibre Optic OBSAI interface - Supports distances of 300m to 3km between the indoor (baseband) and outdoor (radio) units, using different fibre optic modules.
- Sophisticated admission control and dynamic service flow provisioning technology to enable carrier-class VoIP services
- Open network architecture – essential for multi-vendor interoperability

WiMAX from Airspan - your best solution

- Most complete range of WiMAX products in the industry
 - Base stations that support for macro and micro deployment models
 - Comprehensive range of End User Devices for indoor, outdoor and mobile deployment
 - Total network solution including ASN Gateways
 - Scalable solutions to maximize CAPEX and OPEX
- Open architecture enabling interoperability
- Widest range of frequency bands supported of any vendor
- Class-leading spectral efficiency thanks to our advanced RF implementations
- Carrier-class VoIP over WiMAX solutions
 - Sophisticated admission control solution – VoiceMAX
- Advanced and user-friendly network management solutions
- Comprehensive range of professional services to enable you to get the most out of your deployment
 - RF planning services
 - Network design services

Network Architecture

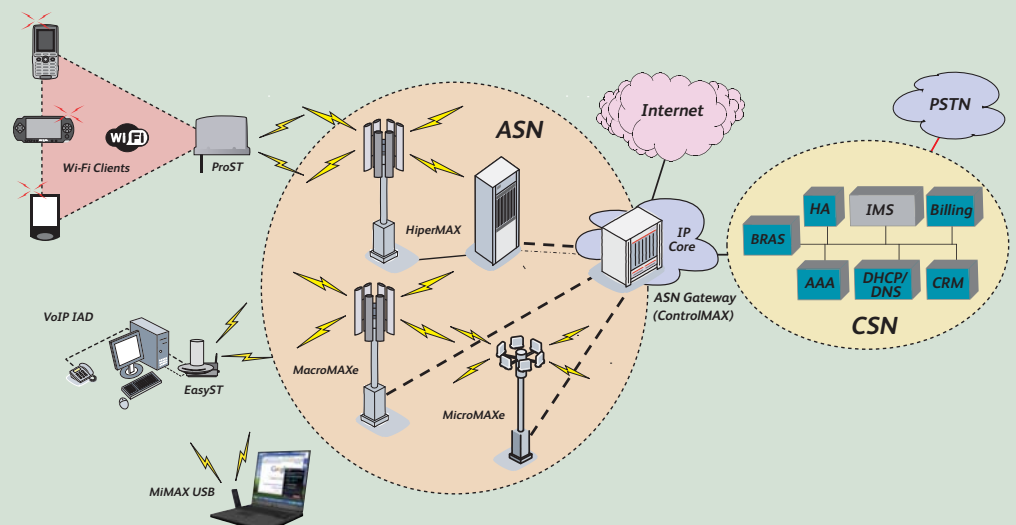



The Ultimate Mobile WiMAX Base Station

Main Features

- HiperMAX supports:
 - Option of split indoor / outdoor or all outdoor configurations
 - Fully redundant architecture
 - Up to 6 channels per ATCA shelf with full redundancy or Up to 12 channels without redundancy
 - Optical, zero-loss connectivity between indoor and outdoor units
- Up to 40dBm transmit power
- Supports FDD and TDD profiles
- Advanced antenna options, including diversity, MIMO and SAS
- Up to 5bps/Hz per radio (2x2 MIMO)
- HiperMAX uses PicoChip® based Software Defined Radio (SDR) array, rated at 4x600 billion instructions/s
- Hybrid beamforming and MIMO enhancements allows multiple simultaneous transmissions to End User Devices
 - Interference avoidance through null forming
 - Key to spectral efficiency enhancements
 - Multiple antenna beams are synthesised at baseband
- Supports Fractional Frequency Reuse utilising PUSC modes in OFDMA

HiperMAX Base Station

- Simultaneous support for both Mobile and Fixed WiMAX profiles
- Flexible packaging - indoor/outdoor or all outdoor
- Advanced RF features for maximized coverage and throughput
- Fully redundant architecture

HiperMAX is the ultimate Mobile WiMAX base station designed for high-density deployment situations. HiperMAX has been architected to provide a highly scalable, fully redundant base station product that will continue to deliver the optimum performance for years to come.

HiperMAX is fully compatible with the Mobile WiMAX Network Reference Model (NRM) as part of the Access Service Network (ASN). HiperMAX supports the reference point (R6) between the base station and the ASN Gateway as well as the reference point (R8) between base stations. HiperMAX interworks with Airspan's ASN Gateway called ControlMAX and with other third party ASN gateways.

HiperMAX represents the state of the art, next generation base station design and includes:

- Fully upgradeable, software defined, PHY and MAC layers enabling simultaneous support for both Mobile WiMAX (SOFDMA) and Fixed WiMAX (OFDM)
- Fully digital, OBSAI based, fibre optic interfaces between indoor baseband and outdoor radio equipment, which can operate at up to 3km.

- Multi-channel transmit and receive diversity
- 2x2 and 4x2 MIMO configurations
- 4 or 8 channel Smart Antenna Systems (SAS)
- Support for FDD and TDD profiles

HiperMAX is designed to deliver the best link budget with the highest capacity and net throughput; all essential qualities for macro-cell deployments used in typical wireless roll out.

HiperMAX implements an all-outdoor radio with up to eight-element antenna array system.

All HiperMAX base stations support SAS and multi-channel Transmit and Receive diversity and are platform ready for SDMA, which uses the antenna array to enhance capacity and improve frequency re-use.

HiperMAX base stations cooperate with the IMS which is part of the Connectivity Service network (CSN) to deliver voice and other multimedia services and can also be configured to support VoIP applications, using a standard media gateway to the PSTN.



HiperMAX mast head units deployed in Vodafone Malta

HiperMAX Operation

The flexibility of the HiperMAX architecture allows many deployment configurations including those suited to both macro and micro cellular installations. It supports all outdoor as well as split indoor / outdoor configurations allowing the operator to select the deployment model best suited to operational expense considerations and site access constraints.

A HiperMAX Base station configured for traditional multi-sector macro-cell deployments consists of a baseband section, suitable for location within a protected environment, and an outdoor RF section. The indoor boards, referred to as blades within the ATCA standard, are housed in a 5 or 14 slot NEBS compliant ATCA chassis. The outdoor enclosure contains the RF subsystem components, which enables smart antenna functionality running on a Software Defined Radio (SDR). The connection between the baseband and RF sections is made through a fibre optic cable.

HiperMAX supports different antenna options including:

- Tx and Rx Diversity
- 2x2 MIMO Matrix A & B
- 4x2 MIMO Matrix A & B
- 4 or 8 element SAS

The antenna system of choice is connected to the outdoor RF unit and in turn to each baseband blade. HiperMAX can support up to 12 baseband blades per 14-slot shelf, with a single fibre optic cable to each RF unit. Baseband blades can be configured to support 6 active channels with full redundancy or 12 active channels without redundancy.

The ATCA shelf also houses the shelf controller and power supplies. In addition to the ATCA shelf, the HiperMAX rack houses the Ethernet switch and the GPS synchronization unit. The Ethernet switch aggregates the individual traffic streams onto a Gigabit Ethernet stream for backhaul purposes. For TDD and smart antenna operation the multiple sectors are locked to a GPS timing source. The ATCA shelf manager provides a platform management layer that holds an inventory of field replaceable units in the system and monitors their status.

Fibre optic modules operating at speeds of up to 3.1Gbit/s and are connected to fibre optic cables capable of carrying up to 10Gb/s for future expansion, if required.

The all outdoor version of HiperMAX is known as HiperMAX-micro. This consists of split baseband and RF sections connected via a fibre interface, but with all components including the power supply and GPS functions housed within a single SDR-micro enclosure. This form factor is particularly well suited to low density micro-cell sites where access to a temperature controlled room is not possible or preferred. eg. a building rooftop.

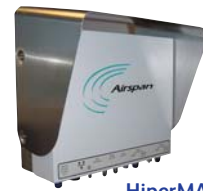

HiperMAX-micro

HiperMAX fully supports the extensive QoS characteristics of the IEEE 802.16e-2005 radio interface. In addition, it incorporates specific additional radio resource management features that allow applications such as VoIP to be robustly delivered by implementing Admission Control on a per call basis.

HiperMAX is managed by Netspan, the SNMP based central management platform.

Network Architecture

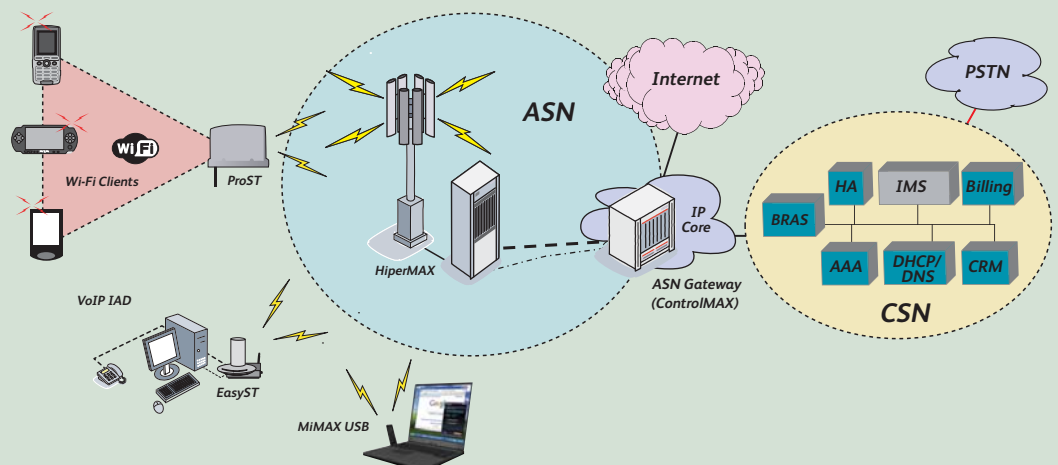



MacroMAXe

Main Features

- Supports 802.16e-2005 SOFDMA
- Initially supports 2.3GHz and 2.5GHz bands
- All-in-one single outdoor unit minimizes site OPEX
- Dual 40dBm radios
 - 60dBm EIRP with front-mounted antennas
- STC and MIMO support
 - Matrix A & Matrix B
- Supports 5/10/20MHz channel size
 - 2x5MHz, 2x10MHz, 1x20MHz
- Supports interoperable reference points defined by NRM
 - Supports interoperable R6 reference point
- Supports 512, 1024, 2048 FFT SOFDMA
- Compact and light form factor
- <20 litre, <20 Kg all-outdoor package
- **Very low power consumption**
 - 200W typical for fully loaded sector
 - 1/3 power consumption of competing products per M/bits of capacity delivered
- Significant CAPEX and OPEX savings

MacroMAX Base Station

MacroMAX is a family of single mode (IEEE 802.16-2004 or 802.16e-2005) highly integrated macro-cell base stations with all-in-one packaging of RF and base-band components. MacroMAX includes integrated dual RF transceivers to support two channel diversity and MIMO.

MacroMAX family comprises of two products:

- **MacroMAXe** - an all outdoor solution for Mobile WiMAX applications to minimize physical footprint and operator OPEX
- **MacroMAXd** - an all indoor solution for Fixed WiMAX applications.

MacroMAXe

- Fully integrated macro-cell Base Station with 2x2 MIMO
- Compact and light-weight form factor for optimum OPEX performance
- Eco friendly - low power consumption reduces carbon footprint
- Support for 2x10MHz or 1x20MHz channels
- Advanced RF features for optimized coverage and throughput

MacroMAXe is a class-leading 2nd generation Mobile WiMAX base station which employs the software defined radio (SDR) technology first developed for HiperMAX, together with dual radio transceivers, antennas and GPS receiver all in a highly integrated, physically small and light, all outdoor package.

MacroMAXe has been primarily developed for the 2.3GHz and 2.5GHz Mobile WiMAX bands and will be Wave 2 certified in these bands. The product has been designed to address the markets needs thru to 2011 and beyond by supporting the current and future air interfaces thanks to its SDR technology.

MacroMAXe is a remarkable base station product bringing together state-of-the-art technologies in a compact all outdoor package. Thanks to its small footprint MacroMAXe minimizes site OPEX expenditure. MacroMAXe is small in size but big in performance. Thanks to the efficient power amplifier technology employed in its RF implementation, MacroMAXe implements dual 40dBm (10W) radios for 2x2MIMO delivering up to 60dBm EIRP with the integrated antennas.

MacroMAXe initially supports 5MHz and 10MHz channel sizes. However, the product is capable of supporting 20MHz channels (Mobile WiMAX

profile Rel. 1.5) as well. MacroMAXe has been designed to support either 2x10MHz (using dual PHY/MAC) or 1x20MHz channel.

MacroMAXe has been conceived for deployment in 3-sector configuration, which is the optimum configuration for Mobile WiMAX deployments. MacroMAXe design also incorporates an Ethernet switch which enables the traffic from 3 sectors to be aggregated for backhaul and network interfacing. MacroMAXe fully supports the interoperable R6 reference point for interworking with ASN Gateways either in a distributed or centralized network configuration.

MacroMAXe is the most power efficient base station in its class. Each 2x10W base station sector draws just 200W of power, 1/3 of competing products per Mbit/s of capacity delivered, thus significantly improving the operator's carbon footprint and OPEX.

MacroMAXe implements Fractional Frequency Reuse (FFR) in order to enable frequency reuse factor of 1 (N=1). FFR controls co-channel interference to support N=1 with minimal degradation in spectral efficiency. MacroMAXe can also be deployed using traditional frequency reuse plans.

MacroMAXd

- Certified for IEEE 802.16-2004 FDD operation
- Widely deployed around the world
- Support Space-Time coding (STC) and Maximal Ratio Combining (MRC)

MacroMAXd is a WiMAX Forum™ certified base station product; one of the first to achieve certification. MacroMAXd has been shipped to customers since 2H 2005.

MacroMAXd has been designed to deliver the best link budget with the highest capacity and net throughput; all essential qualities for macro-cell deployments used in typical wireless rollouts. It is available in the 3.4- 3.6GHz band in the 3.5F1 profile.

Each MacroMAXd sector comprises of a 4U high rack mountable shelf, which contains the baseband processor and the RF unit. The baseband is a single card that is directly connected to the RF, PA and

LNA, which in turn is connected to appropriate mast installed antennas via external feeders.

Two separate antennas enable the link budget to be further increased through the use of multi-channel transmit diversity and receive diversity. A compact rack supports up to three sectors with diversity a full rack supports up to 4 sectors.

Both MacroMAXe and MacroMAXd base stations are managed by Netspan, Airspan's SNMP based element management platform.



MacroMAXd

Main Features

- The first base station to achieve WiMAX Forum™ certification in the FDD profile in March 2006
- Designed for Fixed WiMAX deployments where high capacity is required
- Available in 3.5GHz full FDD profile
- MacroMAXd supports
 - 256 FFT OFDM
 - Up to 35dBm transmit power
 - 3 or 4 diversity channels per rack
 - Baseband to RF connection made digitally
 - Final RF feed using conventional antenna feeders
 - Downlink diversity (Space Time Coding - STC)
 - Uplink diversity (Maximal Ratio Combining - MRC)
 - Up to 10Mbps net capacity using 3.5MHz channel

Network Architecture

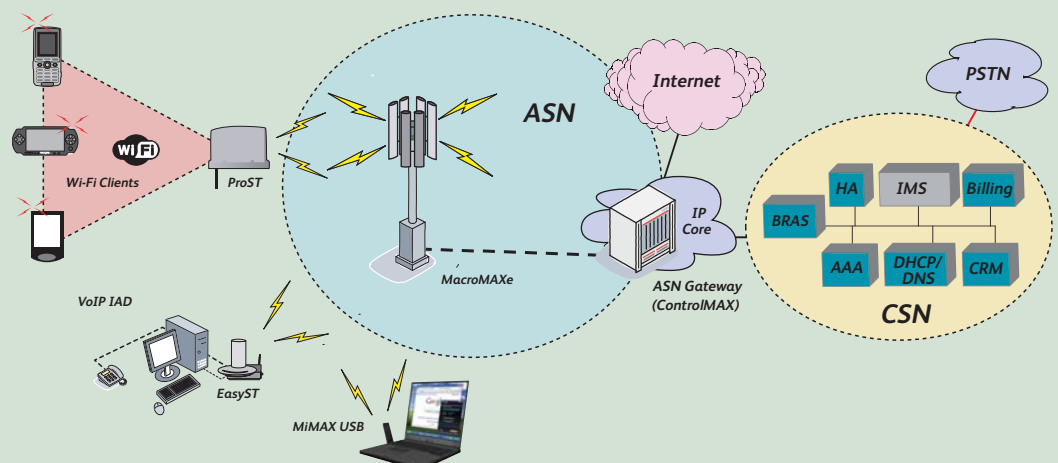



MicroMAXe

Main Features

- Supports 802.16e-2005 SOFDMA Supports wide range of frequency bands
 - 2.3GHz, 2.5GHz, 3.3GHz, 3.5GHz, 3.7GHz, 4.9GHz, 5.4GHz, 5.8GHz
- All-in-one single outdoor unit minimizes deployment costs and site OPEX
- Dual 36dBm radios
- STC and MIMO support
 - Matrix A
 - Matrix B
- Supports 5/10/20MHz channel size
 - 2x5MHz
 - 2x10MHz
 - 1x20MHz
- Supports 512, 1024, 2048 FFT SOFDMA
- Supports interoperable reference points defined by NRM
 - Supports interoperable R6 reference point
- Compact and light form factor

MicroMAX Base Station

MicroMAX is a family of single mode (802.16d or 802.16e) highly integrated micro-cell base stations with all-in-one outdoor packaging of RF and base-band components. For Mobile WiMAX applications, MicroMAXe includes integrated dual RF transceivers to support two-channel MIMO. Performance optimized variants for high density roof-top deployments and cost optimized

variants for low density / rural deployments are available.

MicroMAX family comprises of two products:

- **MicroMAXe** - an all outdoor solution for Mobile WiMAX applications to minimize physical footprint and operator OPEX
- **MicroMAXd** - an outdoor solution for Fixed WiMAX applications with an indoor traffic aggregator.

MicroMAXe

- Fully integrated micro-cell base station
- Compact and light-weight form factor for optimum OPEX performance
- The economic solution for lower density deployments

MicroMAXe is a sophisticated micro-cell Mobile WiMAX base station which employs the software defined radio (SDR) technology first developed for HiperMAX, together with dual radio transceivers, antennas and GPS receiver all in a highly integrated, physically small and light, all outdoor package.

MicroMAXe has been designed to provide a sophisticated yet cost-effective base station solution in less dense deployment situations. The product supports a wide range of licensed and unlicensed frequency bands. It has been designed to address the markets needs thru to 2011 and beyond by supporting the current and future air interfaces thanks to its SDR technology.

MicroMAXe base station product bringing together state-of-the-art technologies in a compact and all outdoor package. Thanks to its small footprint MicroMAXe is easy to deploy and minimizes site OPEX expenditure.

MicroMAXe comes in two variants, a Hi-Power class and a Lo-Power class. MacroMAXe implements dual radios for 2x2MIMO delivering up to 56dBm EIRP with the integrated antennas.

MicroMAXe initially supports 5MHz and 10MHz channel sizes. However,

the product is capable of supporting 20MHz channels (Mobile WiMAX profile Rel. 1.5) as well. MicroMAXe has been designed to support either 2x10MHz (using dual PHY/MAC) or 1x20MHz channel.

MicroMAXe has been conceived for deployment in 3-sector configuration, which is the optimum configuration for Mobile WiMAX deployments. MicroMAXe design also incorporates an Ethernet switch which enables the traffic from 3 sectors to be aggregated for backhaul and network interfacing. MicroMAXe fully supports the interoperable R6 reference point for interworking with ASN Gateways either in a distributed or centralized network configuration.

Spectrum is a scarce and valuable resource which must be used efficiently. In order to achieve frequency reuse factor of one (N=1) the best balance between spectral efficiency and interference mitigation must be achieved. This is realized through Fractional Frequency Reuse for which MicroMAXe has been optimized. Fractional Frequency Reuse controls co-channel interference to support frequency reuse of one with minimal degradation in spectral efficiency. MicroMAXe can also be deployed using traditional frequency reuse plans.

MicroMAXd

- IEEE 802.16-2004 certified for FDD and TDD operation
- Widely deployed around the world
- Highly modular architecture
- Ideal for lower density deployments

MicroMAXd is a complete standalone base station, sharing the same system architecture as our tried and tested ASWipLL product line.

The MicroMAXd base station is highly modular in design and consists of two main components: the all-outdoor Base Station Radios (BSR) and the indoor aggregator Base Station Distribution Unit (BSDU), or the single channel Data Adaptor.

Each base station site can contain up to 16 BSRs, depending on the amount of available spectrum. Each BSR is connected to the BSDU via a 100BaseT interface operating over a Cat5e cable, which carries both data and power over a distance of 300m with Cat5e repeater. Each BSDU can support up to 8 BSRs.

MicroMAXd is designed to support lower density, rural broadband access, enterprise applications and DSL in-fill

scenarios in both licensed (1.5GHz, 3.3GHz, 3.5, 3.7GHz, 4.9GHz) and unlicensed (5.1, 5.4GHz, 5.8GHz, 5.9GHz) bands.

One of the key features of the MicroMAX BSR is that it requires less than 28W power, making it ideally suited for those rural deployments where power generation and supply may be a problem.

MicroMAXd operating in unlicensed bands can be used by Wireless ISPs to deploy WiMAX easily and cost effectively wherever the need is identified.

Both MicroMAXe and MicroMAXd base stations are managed by Netspan, Airspan's SNMP based element management platform.



MicroMAXd

Main Features

- Cost optimized for lower density applications
 - Modular and scalable architecture
 - All outdoor integrated baseband digital processing, radio and antenna
 - Up to 16 radios per mast
- Supports WiMAX Forum™ profiles in 1.5GHz, 3.3GHz, 3.5GHz, 3.7GHz, 4.9GHz, 5.1GHz, 5.4GHz, 5.8GHz and in 5.9GHz bands
- BPSK/QPSK/16QAM/64QAM adaptive modulation
- Full duplex FDD and TDD operation
- Advanced software features
 - Full IEEE 802.16 QoS service classes
 - Full 802.1d transparent bridging
 - IEEE 802.1q/p VLAN tagging/untagging
 - Bridging and routing functionality

Network Architecture

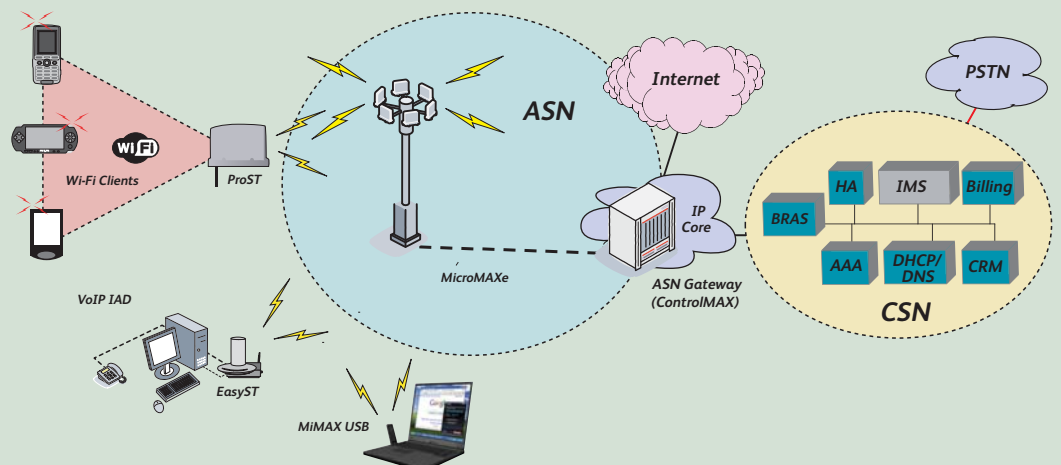

MiMAX USB – Mobile WiMAX Wave 2 USB Device

- First Mobile WiMAX USB device on the market
- Small form factor
- Pure plug-and-play operation
- Quad-band for maximum roaming convenience
- Optional MiMAX Finder for detecting WiMAX networks

Success of Mobile WiMAX depends on the availability of reasonably priced end user devices. Airspan has taken the lead by announcing the world's first Quad-band, Wave 2 Mobile WiMAX, 2x2 MIMO enabled USB device called MiMAX USB (pronounced "My Max").

size delivering up to +22dBm into the antenna. It goes on to deliver an astonishing throughput of up to 33Mbps (in a 10 MHz TDD channel running Matrix B and CSM on uplink). It is power friendly too, looking after the mobile device's battery by supporting sleep and idle features.

The MiMAX USB is the first product in the MiMAX family of MIMO Mobile WiMAX devices and add-ons. It is joined by the optional battery powered MiMAX Finder unit.

MiMAX USB's optional MiMAX Finder accessory is self-powered and provides a simple way of detecting WiMAX coverage availability without powering up the PC mobile PC. It also doubles as a desktop cradle which ensures the unit can be positioned to maximize performance and avoid the RF signal obstructions associated with direct interfaced devices like PCMCIA and PC Express cards.

In order to provide true global roaming, and Inter and Intra country roaming across multiple frequency bands, the MiMAX USB provides quad-band WiMAX operation in a small, power efficient package that sets the levels of size performance standards for the WiMAX industry.

The MiMAX USB incorporates service provider friendly features as well. It supports over the air software upgrades and a SIM card slot, for SIM based authentication.

The MiMAX USB packs a big RF performance despite it's diminutive

MiMAX USB - Mobile WiMAX Device

Main Features

- Wave 2 MIMO Mobile WiMAX compliant USB device
- Allows integration with any device or desktop that supports USB 2.0
- Easy to use, pure "Plug-and-Play" operation
- STC, 2x2 Matrix A MIMO and 2x2 Matrix B MIMO downlink support, and CSM uplink support
- Peak Throughput: Up to 33Mbps
- True Quad-Band operation Enables Global Inter and Intra- Country Roaming
 - 2.3-2.4GHz, 2.496-2.69GHz, 3.3-3.8GHz, 4.9-5.8GHz
- RF Performance
 - SOFDMA
 - 5, 7, 8.75 and 10MHz TDD
 - Tx power (2/3GHz) – 22dBm, Tx Power (4/5GHz) – 17dBm
- Supports:
 - Handover
 - Sleep, idle and paging modes
- Low power consumption (<2.4W)
- SIM card support for SIM based authentication
- Over-the-air download of software upgrades
- Small form factor, only 99x35x8mm
- Battery powered MiMAX Finder Accessory, which enables detection of WiMAX coverage without turning on the PC





For Self Install Indoor Deployments

Main Features

- Supports both Mobile WiMAX and Fixed WiMAX profiles
- World's first "Self-Install" WiMAX CPE
- Full indoor non-LOS (NLOS) deployment
- User unpacks, plugs in and surfs - Installation takes less than 1 minute!
- Utilizes latest Intel WiMAX chipset
- Optional IEEE 802.11b/g Wi-Fi access point
- Optional VoIP base for 1 or 2 POTS lines
- A range of antenna options
- Up to 8.5dBi, 4 x 90° auto selecting antenna
- Full support for Sub-Channelization (OFDMA on uplink)
- Integral SIM card reader
- "Auto-Connect" and "Auto-Config" features
- Full Nomadic Operation

EasyST-2

- Indoor "self-install" CPE
- Small form factor and built-in antenna
- Supports Mobile and Fixed WiMAX profiles
- Optional Stackable Wi-Fi and VoIP units

EasyST and ProST CPE products have been developed to work with all WiMAX compliant base stations including all base stations from Airspan. The EasyST is an all-indoor CPE designed for self-install by the end user whereas the ProST is a part indoor part outdoor CPE which requires professional installation and provides superior link budget in difficult deployment conditions.

The EasyST is a physically compact WiMAX CPE designed to be deployed alongside the end user's PC. EasyST looks great when sitting on a desk or window sill.

The EasyST is designed to be installed by the end user, using a simple-to-use but sophisticated user interface to enable optimum positioning without needing to switch-on the user's PC. This helps improve service availability and reliability whilst increasing service speed and reducing network load.

Three different deployment models are supported: using the integral 4 x 90° antenna; using together with the optional Wi-Fi expansion (thus locating the EasyST by a window); or using an external antenna. In all cases a visual indication system informs the user when the optimum location for RF reception and transmission is achieved.

The latest generation EasyST, called EasyST-2, is based on the Rosedale 2 chipset from Intel and is capable of supporting both Mobile WiMAX and Fixed WiMAX profiles. Simply through software the device can be configured to support one or the other profile.

EasyST is designed for combined voice and data deployments.

EasyST has two optional "stackable" extension bases, one for Wi-Fi and the other for VoIP and data.



EasyST with EasyWiFi

EasyWiFi

The Wi-Fi expansion base provides full IEEE 802.11b/g Access Point functionality and turns each EasyST into an instant hot spot, with the WiMAX radio interface providing backhaul for IEEE 802.11b/g clients. Thanks to IEEE 802.16 QoS built into the EasyST, Wireless SIP phones can make high quality, managed VoIP calls.



EasyST with EasyVoice

EasyVoice

Voice and data applications are supported by the VoIP expansion base, which supports 2 voice lines and an Ethernet port, thus providing services to standard, RJ-11 equipped telephone instruments. Battery backup can also be provided, where applicable, and uses simple AA rechargeable NiMH cells. The VoIP expansion base is fully managed by Airspan's base stations and VoiceMAX solution to ensure a fully transparent, carrier-class voice service.



Rapid and Simple External Deployment

Main Features

- Suitable for full outdoor Non-LOS deployment
 - Based on field-proven mechanics
- ProST and ProST-WiFi are available in a wide range of frequencies including:
 - 3.3GHz, 3.5GHz, 3.7GHz, 4.9GHz, 5.1GHz, 5.4GHz 5.8GHz, 5.9GHz
- Comprehensive range of indoor Subscriber Data Adaptors (SDA)
 - 1-4 port Switch
 - Up to 4 ports with VLAN switching
 - Indoor and Outdoor IEEE 802.11b/g Wi-Fi and VoIP support
 - AC or DC powering options
- Outdoor and indoor units connected using CAT5e cable
- Built-in antenna gain of 17dBi
- Industrial strength Wi-Fi AP
 - Tx power – 16dBm
 - Antenna gain – 2dBi
 - 16 SSIDs
 - Transparent Layer 2 bridge
 - IEEE 802.1q VLAN support

ProST-2 and ProST-2-WiFi

- Designed for outdoor deployment
- Ensures high service availability over long distances
- Outdoor WiMAX CPE with integrated Wi-Fi Access Point functions
- Environmentally hardened design

ProST is a customer premises equipment for outdoor deployment. It is designed for rapid and simple external deployment, to be fitted by trained personnel in less than one hour. The operator would deploy the ProST when a specific service level needs to be guaranteed to the end customer. The ProST ensures high service availability at enhanced ranges, operating in both LOS and NLOS propagation environments.

ProST product family has two models:

- **ProST-2** which delivers WiMAX access
- **ProST-2-WiFi** which delivers WiMAX access together with integrated Wi-Fi capability.

To obtain a basic service capability, the ProST would not require programming with any initial configuration data. However, to deliver service to the ProST will require the management system to authenticate the customer's equipment using the internal X.509 certificate. This may be achieved automatically (through a web based registration service) or via a telephone call to a central administration centre.

ProST supports a two piece design comprising of the outdoor unit (ODU) which contains the radio, the antenna and the baseband processor in an environmentally robust enclosure, and a family of indoor adapters called Subscriber Data Adapter (SDA) designed to support the delivery of a range of end-user services. Service interface options include:

- 1 to 4 Port Switch
- 4 port with VLAN Port Switching
- Integral 802.11b/g WiFi Access Point (SDA-WiFi)
- Integral VoIP IAD (SDA-MSG)

Pro-ST users can benefit from VoIP services and indoor WiFi coverage by deploying the SDA-MSG and SDA-WiFi units respectively.



SDA-MSG

SDA-WiFi

SDA-MSG comprises of the EasyVoice unit plus a Power Supply Adaptor (PSA). The SDA-WiFi consists of the EasyWiFi unit plus PSA.

The latest generation ProST called ProST-2 is based on the Rosedale 2 chipset from Intel and is capable of supporting both Mobile WiMAX and Fixed WiMAX profiles. Simply through software the device can be configured to support one or the other profile.

ProST-WiFi, in addition to the WiMAX access also supports an outdoor integrated IEEE 802.11b/g Access Point inside of the same ProST ODU enclosure. This solution enables ProST-WiFi to provide outdoor Wi-Fi coverage with WiMAX backhaul thus ensuring the rapid rollout of Wi-Fi Hotzones. ProST-WiFi operates over the full ProST temperature range and includes industrial strength IEEE 802.11b/g technology that supports 16 SSIDs per CPE and SSID to VLAN and VLAN to IEEE 802.16 Service Flow mapping.

ProST and ProST-WiFi can be managed by Airspan's Web-based management system or Netspan element manager.



AN-1



ST-16/
ST-40

ControlMAX

Main Features

- Profile C ASN Gateway family
- ControlMAX generic functions
 - Traffic aggregation and routing
 - MS admission control
 - Manage handover of MS between base stations
 - Policy enforcement
 - Security management
 - Accounting
 - Connection management
- Three platforms AN-1, ST-16 and ST-40

AN-1

- Smaller scale, cost effective solution
- Utilizes PC blade as hardware platform

ST-16

- High availability
- Redundant architecture with no single point of failure
- Supports Home Agent functions
- Centralized architecture
- Can manage up to 1000 BS and 500k sessions

ST-40

- Same fault tolerant platform as the ST-16
- Can manage up to 4000 BS sectors and 9000 call events/s

ControlMAX – Airspan’s Mobile WiMAX ASN Gateway Solution

- A family of ASN Gateways to suit all network needs
- Scalable – from entry level to high performance models
- Optimized CAPEX utilization
- Fault tolerant hardware architecture

The IEEE 802.16e-2005 standard and the WiMAX Forum™ Network Reference Model (NRM) divide the WiMAX network into two main parts:

- Access Service Network (ASN) and
- Connectivity Service Network (CSN).

The ASN consists of the WiMAX base stations and the ASN Gateway (ASN-GW). ASN-GW controls and aggregates the traffic from a large number of WiMAX base stations. CSN is at the core of the network providing control and management functions such as IMS, DHCP, FTP and AAA.

Airspan’s ASN-GW product family is called ControlMAX. In collaboration with Starent Networks, Airspan provides three ASN-GW products: AN-1, ST-16 and ST-40. All of these products support the Profile C R6 interface to the base station. ControlMAX offerings utilize common ASN-GW software, with different hardware architecture suited to particular deployment models as described below.

AN-1 Entry level ASN-GW

AN-1 is an entry level, low cost ASN-GW optimized for distributed architecture, enabling cost effective deployment at base station sites. AN-1 operates on a high performance server

blade, supporting geographic redundancy if necessary.

ST-16 High availability ASN-GW

ST-16 is a centralized ASN-GW on a high availability hardware platform with no single point of failure. All cards, fan trays and power units are hot pluggable, with the software supporting session recovery and online software upgrades.

The ST-16 is highly scalable and enables multiple functions such as ASN-GW, Home Agent, Session Control Manager, Paging Controller and Inline Services to run on the same platform.

ST-16 is the ideal platform for providing a highly reliable centralized ASN-GW, with an impressive set of advanced features for operating a Mobile WiMAX network, allowing interoperability with other access technologies.

ST-40 High availability, High Performance ASN-GW

ST-40 is the ideal platform for large ASN deployments. It is based on the same hardware architecture as the ST-16 and is capable of supporting even more base stations and call events than the ST-16.

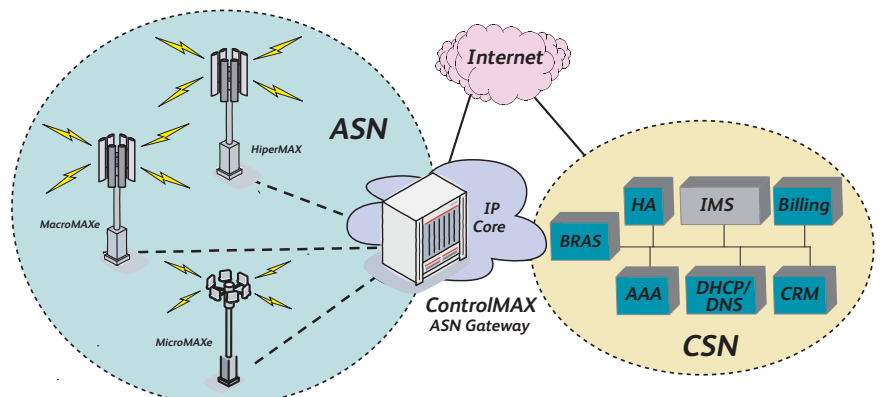

VoiceMAX

- Provides carrier-class voice quality over wireless IP
- SIP based protocol
- Supports end user devices from other vendors
- Service Provider defined policy management and enforcement



The SIP based Admission Control Server

Main Features

- Enables carrier-class VoIP services with no need for client software in the end user devices
- VoiceMAX functions
 - Auto discovery of end users simplifies the registration process
 - Admission Control for managing network resources according to service provider policy
 - Emergency calls prioritization
 - Dynamic UGS management for effective bandwidth utilization
- VoiceMAX architecture
 - SIP based software product deployed on a standalone server in the core network
 - Rack mountable
- VoiceMAX management
 - Local console
 - Over the Internet

Carrier-class VoIP requires constant, uninterrupted data flow. In an ideal world packets would not arrive out of sequence or suffer from delays or packet lost. In a shared medium such as wireless access, the amount of carried traffic may fluctuate from one moment to the next causing delay and jitter. Therefore, carrier-class VoIP over wireless cannot be left to chance.

Airspan has deployed in-house expertise in both wireless and voice technology in order to bring a unique, SIP based solution to Voice over Wireless IP (VoWIP), we call VoiceMAX.

VoiceMAX is a standalone server which makes best use of the advanced admission control mechanisms and QoS features of the IEEE 802.16 standard.

VoiceMAX is deployed in the core network, in CSN. It communicates with the WiMAX base stations and with the Softswitch, using SIP protocol, in order to dynamically allocate WiMAX network resources to originating and terminating VoIP calls to ensure desired voice quality, at the same time minimizing waste of pre-assigned bandwidth.

The standalone VoiceMAX server performs the following functions:

- Auto discovery of the end users - VoiceMAX acts as a standard SIP proxy intercepting all SIP messages. The registration packet triggers the "Auto Discovery" mechanism, which at the end of the process gives the VoiceMAX the ability to determine, to which BS a specific end user (SIP User Agent) belongs, thus simplifying the registration process.
- Admission control – VoiceMAX prevents over subscription of network resources in accordance with the policies of the service provider. Enables emergency numbers to be prioritized.
- Dynamic UGS - VoiceMAX provides the ability to dynamically create and tear down UGS sessions. Using this mechanism, it enables guaranteed bandwidth utilization in accordance with the negotiated codec selection.

VoiceMAX can be managed either from the local console or remotely over the Internet.





Operations & Management Platform

Main Features

- Manages Mobile WiMAX and Fixed WiMAX network elements
- Airspan's WiMAX products support three management options:
 - Local web based client management of individual system components
 - Used to configure small systems and networks
 - North-bound interface to third party Network Management
 - Management via third party SNMP management tool
 - Uses standard WiMAX MIB
- Airspan's Netspan network management server
 - Already running numerous WiMAX networks worldwide
 - Based on Microsoft .Net platform
 - Distributed server architecture support
 - Full system configuration, operation and maintenance via standard web client
 - SNMP API support
 - Uses standard WiMAX MIB for all configuration and O&M activities

Netspan – Element Manager for WiMAX

- Element Manager for Airspan's base stations and end user devices
- Optimized for effective management of WiMAX networks
- Captures the real-world experience gained over many years in hundreds of networks deployed

Airspan's WiMAX products incorporate all the features that are required for the initial installation and commissioning of the products as well as their day-to-day efficient running. To this end, all products include comprehensive management capabilities in terms of features designed into the products as well as the centralized Operations & Management (O&M) system, Netspan.

Netspan has been developed as a comprehensive element manager that supports Mobile and Fixed WiMAX deployments of other vendor's products as well as Airspan's products.

Netspan provides the following functions:

- Fault management
- Configuration management
- Alarm handling
- Performance management
- Security management

Netspan is designed around a client/server architecture. The Netspan server runs on a PC platform, making use of an SQL database to store the

configuration, statistics and alarm history from the radio network. Access to the Netspan server is from Microsoft Internet Explorer, using the web service of the Netspan server.

The Netspan O&M has terminal mobility service support from day 1, enabling roaming and self-installation by customers using, MiMAX USB, EasyST and ProSTs.

Auto-CPE provisioning and Auto-Service Flow and Service Product allocation ensures that the network operator can take advantage of any compatible WiMAX Certified CPE that connects to his network. Network Authentication is managed separately from service provisioning and activation, which is a fundamental part of any mobile system design.

Each Netspan operator is given configurable access rights, allowing each operator to be granted the rights appropriate to their function.

Netspan provides configuration and diagnostic access to every WiMAX network element, right down to each individual Subscriber Terminal.

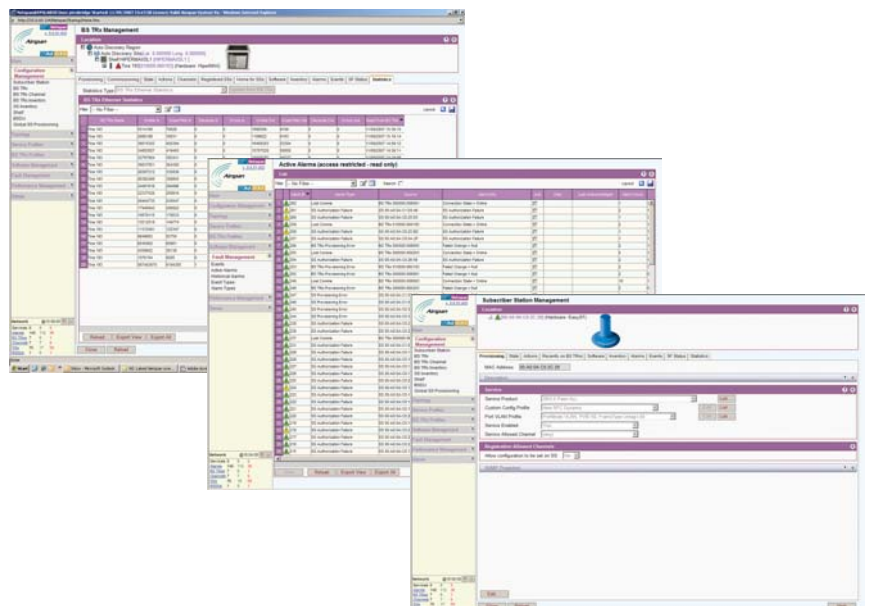

Technical Datasheet - Base Stations

	HiperMAX	MacroMAXe	MacroMAXd
Mobile WiMAX	Yes	Yes	No
Fixed WiMAX	Yes	No	Yes
Standards Compliance	IEEE802.16e-2005 IEEE802.16-2004	IEEE802.16e-2005	IEEE802.16-2004
Form Factor	Split Indoor / Outdoor and all Outdoor	All Outdoor	Indoor
Frequency Bands	2.3GHz, 2.5GHz, 3.3GHz, 3.5GHz, 3.7GHz, 4.9GHz (700MHz - Future)	2.3GHz, 2.5GHz, 3.5GHz (700MHz - Future)	3.5GHz
Channel Size	20MHz, 2x10MHz, 10MHz, 7MHz, 5MHz, 3.5MHz, 1.75MHz	20MHz, 2x10MHz, 10MHz, 5MHz	3.5MHz
FFT	2048, 1024, 512, 256	2048, 1024, 512	256
Duplex Method	TDD, FDD, H-FDD	TDD (FDD - Future)	FDD
Tx Power (Frequency band dependant)	Up to 4x +40dBm	2x +40dBm	2x +35dBm
Maximum EIRP per sector	+63dBm	+60dBm	+53dBm
GPS Synchronization	24hr holdover, Distributed	8hr holdover, Integrated	No
STC	Yes	Yes	Yes
MRC	Yes	Yes	Yes
MIMO	4x2, 2x2	2x2	No
MIMO Matrix Type	Matrix A, Matrix B	Matrix A, Matrix B	No
CSM	Yes	Yes	No
Beamforming	Yes	No	No
Uplink Sub-Channelization	Yes	Yes	Yes
PUSC	Yes	Yes	No
Fractional Frequency Reuse	Yes	Yes	No
Dynamic Frequency Selection (DFS)	No	No	No
Ethernet CS	Yes	Yes (Future)	Yes
IP CS	Yes	Yes	No
IP version support	IPv6, IPv4	IPv6, IPv4	IPv4
Network Interface	1000bT Ethernet / R6	1000bT Ethernet / R6	100bT Ethernet
End to End VLAN (802.1Q)	Yes	No	Yes
Network VLAN Traffic Segregation	Yes	Yes	Yes
ASN Profile	Profile C	Profile C	No
Supported Usage Scenarios	Mobile, Portable, Nomadic, Fixed	Mobile, Portable, Nomadic, Fixed	Nomadic, Fixed
Handover Supported	Yes	Yes	No
Encryption	DES, AES	AES	DES, AES
Authentication	PKM, PKMv2, EAP-TLS, EAP-AKA, EAP-SIM	PKM, PKMv2, EAP-TLS, EAP-AKA, EAP-SIM	PKM
Environmental (outdoor elements)	ETS 300 019-1-4 Class 4.1E	ETS 300 019-1-4 Class 4.1E	ETS 300 019-1-4 Class 4.1E
Environmental (indoor elements)	ETS 300 019-1-3 Class 3.2	-	ETS 300 019-1-3 Class 3.2

Note: Specifications are subject to change without notice and are for information purposes only.

MicroMAXe	MicroMAXd	
Yes	No	Mobile WiMAX
No	Yes	Fixed WiMAX
IEEE802.16e-2005	IEEE802.16-2004	Standards Compliance
All Outdoor	Split Indoor / Outdoor	Form Factor
2.3GHz, 2.5GHz, 3.3GHz, 3.5GHz, 3.7GHz, 4.9GHz, 5.4GHz, 5.8GHz, (700MHz - Future)	1.5GHz, 3.3GHz, 3.5GHz, 3.7GHz, 4.9GHz, 5.1GHz, 5.4GHz, 5.8GHz, 5.9GHz	Frequency Bands
20MHz, 2x10MHz, 10MHz, 5MHz	10MHz, 5MHz, 3.5MHz, 1.75MHz	Channel Size
2048, 1024, 512	256	FFT
TDD (FDD - Future)	TDD, FDD	Duplex Method
Up to 2 x +36dBm	+27dBm	Tx Power (Frequency band dependant)
56dBm	44dBm	Maximum EIRP per sector
8hr holdover, Integrated	Distributed	GPS Synchronization
Yes	No	STC
Yes	No	MRC
2x2	No	MIMO
Matrix A, Matrix B	No	MIMO Matrix Type
Yes	No	CSM
No	No	Beamforming
Yes	Yes	Uplink Sub-Channelization
Yes	No	PUSC
Yes	No	Fractional Frequency Reuse
Yes	Yes	Dynamic Frequency Selection (DFS)
Yes (Future)	Yes	Ethernet CS
Yes	No	IP CS
IPv6, IPv4	IPv4	IP version support
1000bT Ethernet / R6	100bT Ethernet	Network Interface
No	Yes	End to End VLAN (802.1Q)
Yes	Yes	Network VLAN Traffic Segregation
Profile C	No	ASN Profile
Mobile, Portable, Nomadic, Fixed	Nomadic, Fixed	Supported Usage Scenarios
Yes	No	Handover Supported
AES	DES, AES	Encryption
PKM, PKMv2, EAP-TLS, EAP-AKA, EAP-SIM	PKM	Authentication
ETS 300 019-1-4 Class 4.1E	ETS 300 019-1-4 Class 4.1E	Environmental (outdoor elements)
-	ETS 300 019-1-3 Class 3.2	Environmental (indoor elements)

Note: Specifications are subject to change without notice and are for information purposes only.

Technical Datasheet - End User Devices

	MiMAX USB	EasyST-2	ProST-2
Mobile WiMAX	Yes	Yes	Yes
Fixed WiMAX	No	Yes	Yes
Standards Compliance	IEEE802.16e-2005	IEEE802.16e-2005 IEEE802.16-2004	IEEE802.16e-2005 IEEE802.16-2004
Form Factor	USB 2.0	Indoor Self-Install	Outdoor
Frequency Bands	Quad Band Device 2.3-2.4GHz, 2.496-2.69GHz, 3.3-3.8GHz, 4.9-5.8GHz (700MHz - Future)	1.5GHz, 3.3GHz, 3.5GHz, 3.7GHz, 4.9GHz, 5.8GHz	1.5GHz, 3.3GHz, 3.5GHz, 3.7GHz, 4.9GHz, 5.1GHz, 5.4GHz 5.8GHz, 5.9GHz
Channel Size	10MHz, 8.75MHz, 7MHz, 5MHz	10MHz, 7MHz, 5MHz, 3.5MHz, 1.75MHz	10MHz, 7MHz, 5MHz, 3.5MHz, 1.75MHz
FFT	512, 1024	1024, 512, 256	1024, 512, 256
Duplex Method	TDD	TDD, FDD	TDD, FDD
Tx Power (Frequency band dependant)	Up to 22dBm (2.3-2.4GHz, 2.496- 2.69GHz, 3.3-3.8GHz) up to 17dBm (4.9-5.8GHz)	+24dBm	+24dBm
Rx Sensitivity	-100dBm @5MHz (QPSK) compliant with MRCT 1.0	-103dBm	-103dBm
STC	Yes	Yes	Yes
MIMO	2x2	No	No
MIMO Matrix Type	Matrix A, Matrix B	No	No
CSM	Yes	Yes	Yes
Beamforming	Yes	No	No
Uplink Sub-Channelization	Yes	Yes	Yes
PUSC	Yes	Yes	NO
Fractional Frequency Reuse	Yes	Yes	NO
Ethernet CS	No	Yes	Yes
IP CS	Yes	Yes	Yes
IP version support	IPv6, IPv4	IPv6, IPv4	IPv6, IPv4
User Interface	USB 2.0	10/100bT Ethernet, WiFi, POTs with integrated RGW	10/100bT Ethernet, WiFi, POTs with integrated RGW
End to End VLAN (802.1q)	No	Yes	Yes
Supported Usage Scenarios	Mobile, Portable, Nomadic	Nomadic, Fixed	Fixed
Handover Supported	Yes	Yes	No
Encryption	AES	DES, AES	DES, AES
Authentication	PKMv2, EAP-TLS, EAP-AKA, EAP-SIM	PKM, PKMv2, EAP-TLS, EAP-AKA, EAP-SIM	PKM, PKMv2, EAP-TLS, EAP-AKA, EAP-SIM

Note: Specifications are subject to change without notice and are for information purposes only.

Technical Datasheet - ControlMAX

	AN-1	ST-16	ST-40
ASN-GW	•	•	•
Home Agent		•	•
Enterprise Access Gateway		•	•
WiMAX	•	•	•
WiFi		•	•
Open R6 Interface	•	•	•
Distributed Profile C ASN Support	•	•	•
Centralized Profile C ASN Support	•	•	•
User Authentication	•	•	•
Device Authentication	•	•	•
Micro Mobility	•	•	•
Macro Mobility	•	•	•
Paging Controller		•	•
Location Register		•	•
Mobile IP	•	•	•
Simple IP	•	•	•
Enhanced Charging Service		•	•
Intelligent Traffic Control		•	•
Stateful Firewall		•	•
Content Filtering		•	•
Peer-to-peer Detection & Control		•	•
Reporting / Session Monitoring		•	•
Session Recovery		•	•
Geographic Redundancy	•	•	•
L2TP LAC		•	•
IPSec Encryption		•	•
Prepaid Accounting		•	•
Post Paid accounting		•	•
Hotlining Accounting		•	•
Destination Based accounting		•	•
Layer 2 Traffic Management		•	•
Enhanced Lawful Intercept		•	•
Web Element Manager	•	•	•

Note: Specifications are subject to change without notice and are for information purposes only.

Technical Datasheet - Netspan

Communications & Networking	<ul style="list-style-type: none"> • Simple Object Access Protocol (SOAP) Northbound Interface for alarms and provisioning • Physical Connectivity: Ethernet • Client-Server: HTML over HTTP • Equipment Management: SNMP • Database: SQL
Fault Management	<ul style="list-style-type: none"> • Events and Traps from 802.16f MIB and Private MIB • Active Alarm Monitoring • Alarm Customisation • Alarm Acknowledgement & Clear • Historical Storage / Logging of Alarms • Alarm and Event Filtering • Alarm Tracking
Configuration Management	<ul style="list-style-type: none"> • Inventory Management • Auto discovery of network elements • Manual entry of network elements • Base Station Commissioning & Provisioning • Service Provisioning • State Tracking of all network elements • Status Reporting of each network element • Network wide status reports • Software Management • Software download scheduling • Import / Export of Configuration Profile
Performance Management	<ul style="list-style-type: none"> • Periodic Measurements • On Demand Measurements • Display of key performance indicators • Retrieval of RF Performance Statistics, Packet Counters and Ethernet Counters of all network elements • Historical storage / logging of statistics • Export of statistics data
Security Management	<ul style="list-style-type: none"> • Password and Security Policy Management • Encrypted Password Storage • Form based authentication • Role based authentication • User activity logging • Multi-user support
Northbound Interface	<ul style="list-style-type: none"> • Service Provisioning • Service Profile Definition • Inventory • Active Alarm Management
Database Management	<ul style="list-style-type: none"> • Management of Fault and Event Storage • Management of Statistics Storage • Database Integrity Checks • Integrated Database Administration
GUI	<ul style="list-style-type: none"> • Utilizes AJAX Technology for enhanced client experience • Support for customised user interface, including lists, home page, etc. • Integrated Help system • Advanced Filters and Search capabilities for rapid troubleshooting
Redundancy	<ul style="list-style-type: none"> • Protection against failure of Services • Full SQL redundancy • Distributed Architecture for full server redundancy • Support for RAID Controller for disk redundancy

Base Station Products

HiperMAX	The most advanced base station which incorporates MIMO, beamforming and high availability. Designed to deliver optimum capacity and net throughput for Fixed and Mobile WiMAX applications in both FDD and TDD.
MacroMAXd	A high performance base station with transmit and receive diversity designed for both fixed and nomadic applications in FDD for urban and suburban deployments.
MacroMAXe	Highly integrated macro-cell base station with all-in-one outdoor packaging of RF and baseband components. Includes dual RF transceivers for dual channel diversity or MIMO support.
MicroMAXd	Cost effective, highly modular base station designed for lower density deployments and micro-cell applications in both FDD and TDD.
MicroMAXe	Highly integrated micro-cell base station with all-in-one outdoor packaging of RF and baseband components. Includes dual RF transceivers for dual channel diversity or MIMO support.

End User Devices

MiMAX USB	A revolutionary Quad-band USB device that turns any laptop into a Mobile WiMAX client thus enabling user mobility and roaming.
EasyST	A revolutionary indoor, self-install WiMAX Subscriber Station with optional IEEE 802.11b/g Wi-Fi and Voice over IP (VoIP) add-ons.
EasyWiFi	An IEEE 802.11b/g Wi-Fi Access Point, which tightly integrates with the EasyST to create a combined WiMAX-WiFi unit for residential use.
EasyVoice	A residential gateway unit with 2 VoIP ports and 1 Ethernet port that integrates with the EasyST to create a combined voice and data WiMAX Subscriber Station with VoIP and Ethernet ports.
ProST	An environmentally hardened outdoor Subscriber Station developed to provide superior link budget performance in difficult deployment conditions. Requires professional installation. Delivers VoIP services when used with SDA-MSG (Multi-Services Gateway).
ProST-WiFi	A ProST with a Wi-Fi Access Point integrated into the same outdoor enclosure. Enables integrated WiMAX and Wi-Fi applications in outdoor public spaces.

Network Products

ControlMAX	Airspan's Access Services Network (ASN) gateway product family which includes the ST-16 and the AN-1 products. An essential component of any Mobile WiMAX network.
VoiceMAX	Enables WiMAX networks to deliver robust SIP based services such as VoIP and video, with integrated Admission Control for ensuring carrier-class voice quality.

Network Management Products

Netspan	A comprehensive element management solution that manages all of Airspan's WiMAX network elements.
---------	---

Glossary

ASN	Access Service Network	OBSAI	Open Base Station Standard Initiative
ATCA	Advanced Telecommunications Computing Architecture	OFDM	Orthogonal Frequency Division Multiplexing
BWA	Broadband Wireless Access	OFDMA	Orthogonal Frequency Division Multiplexing (Multiple Access)
CPE	Customer Premises Equipment	PHY	PHYSical Layer
CSN	Connectivity Service Network	SAS	Smart Antenna System
FDD	Frequency Division Duplex	SDMA	Spatial Division Multiple Access
IMS	IP Multimedia Subsystem	SDR	Software Defined Radio
LNA	Low Noise Amplifier	SIP	Session Initiation Protocol
MAC	Media Access Control Layer	SOFDMA	Scalable OFDMA
MIMO	Multiple Input Multiple Output	STC	Space-Time Coding
MRC	Maximal Ratio Combining	TDD	Time Division Duplex
NLOS	Non Line of Sight	VoIP	Voice over IP

*How to find out
more about Airspan's
products and solutions*

For more information about Airspan, its products and solutions, please visit our website:

www.airspan.com

Or write to us at one of the addresses below.

We will be delighted to send you additional information on any of our products and their applications around the world.

Airspan has sales offices in the following countries:

Europe

Finland

Poland

Russia

United Kingdom

Middle East

United Arab Emirates

Africa

South Africa

Americas

United States

Asia Pacific

Australia

China

India

Indonesia

Japan

Philippines

Sri Lanka



Worldwide Headquarters;
Airspan Networks Inc.
777 Yamato Road, Suite 310,
Boca Raton, FL 33431-4408, USA
Tel: +1 561 893 8670 Fax: +1 561 893 8671

Main Operations;
Airspan Communications Limited
Cambridge House, Oxford Road,
Uxbridge, Middlesex, UB8 1UN, UK
Tel: +44 (0) 1895 467 100 Fax: +44 (0) 1895 467 101

www.airspan.com

001-0107-006 Rev H